

**QUASAR**  
H O L L A N D

**QUASAR**  
H O L L A N D



**QUASAR**  
H O L L A N D

**QUASAR**  
H O L L A N D



# JULIA

designed by Daniel Becker for Quasar Holland

Julia is a lighting series that includes table-, wall- and standing lamps as well as a chandelier and several pendant lamps.

Each one consists of two shades: the outer which is handmade of brass, while the fragile inner one is made of translucent glass.

The latter also serves as the light diffuser and a shell in which an LED bulb can be hidden.

Both shades are connected to a classic table lamp in a way which signifies the present archetypal gesture. At the same time, the product itself creates a testimony of contemporary living.



# DANIEL BECKER

The Designer

Julia is the third design after Sparks and Elaine which Daniel Becker (born 1983) created for Quasar Holland.

He studied industrial design at Braunschweig University of Art and is based in Berlin since 2010.

After graduating he opened his own studio and was invited to show his work in several young design talent selections on major trade fairs.

In 2014, he has been nominated for the Newcomer Award by the German Design Council.

In 2015 he was awarded with the Good Design Award by the Chicago Athenaeum, the world's oldest design award. His work is regularly exhibited and published worldwide.

His focus is on luxury lighting design, aside of working for manufacturers he also produces fixtures under his own label.



# QUASAR

The brand

Quasar manufactures all lighting fixtures by hand in their headquarters in Giessen, The Netherlands. All models can be customised in size, colour and finish - a unique advantage against many competitors.

The brand made its first appearance on an international fair on the 1992 EuroLuce Milan and continued to grow since then to one of Europe's most unique and creative lighting manufacturers with an export rate of 75% of its production.





detail of the shade



# JULIA

Development

The development of Julia started with the briefing to design a table lamp for the hospitality sector.

We looked into many historical examples and decided to combine two archetypical shapes from that sector - the plissee shade and a spherical glass shade.

Our decision was to reinterpret the plissee shade in metal. The material is the most representative for Quasar as a brand and offers many options for customisation, something crucial in the hospitality sector.





wall lamp

# JULIA

Model overview

The following pages present all available standard versions of the series. Aside these, any customised size or finish is available on request.



standing lamp



circular version, Ø 70cm, brass



circular version, Ø 100cm, brass



circular version, Ø 130cm, chrome



circular version, Ø 160cm, brass



long version, four shades, brass





long version, six shades, chrome

# JULIA

Single shades



table lamp

## MATERIALS

Stainless steel  
Frosted glass

## FINISHES

polished chrome  
satin brass

black textile cable for  
table & standing lamps

bespoke finishes available on request

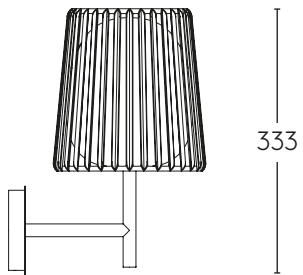

246

Wall lamp

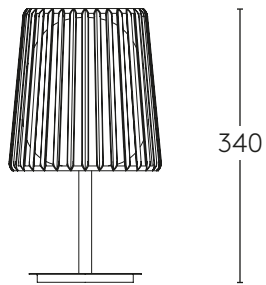

192

Table lamp

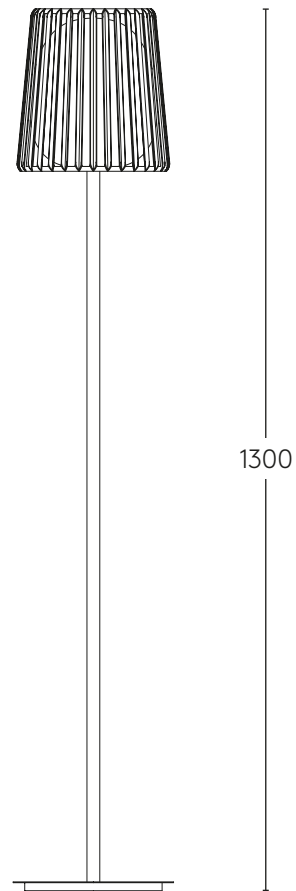

192

Standing lamp

# JULIA

Chandeliers



small chandelier

## MATERIAL

Stainless steel  
Frosted glass

## FINISHES

polished chrome  
satin brass

bespoke finishes available on request

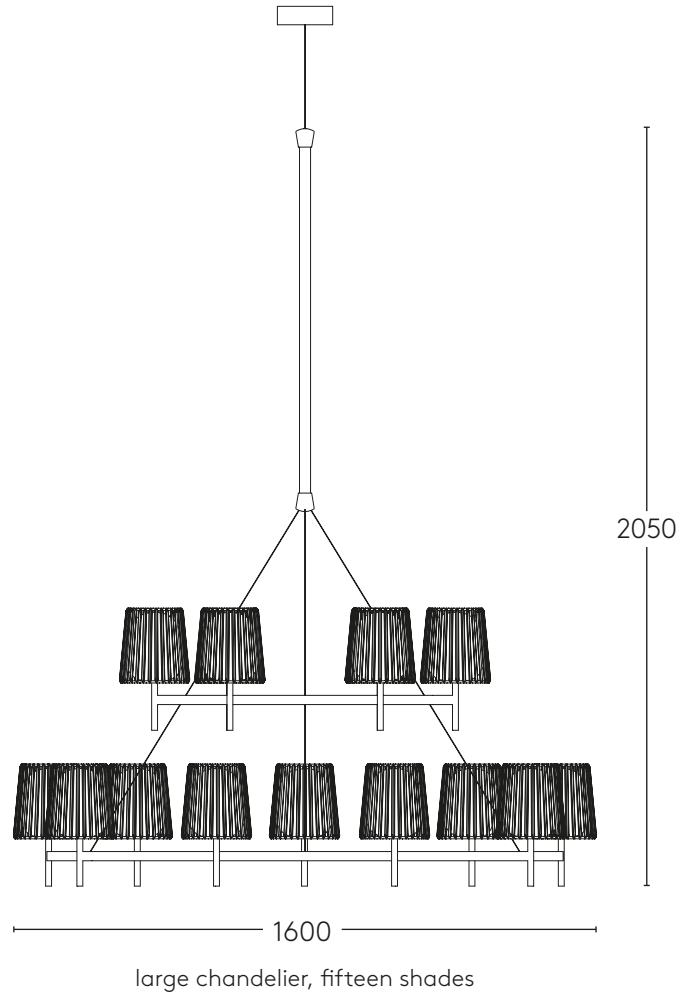
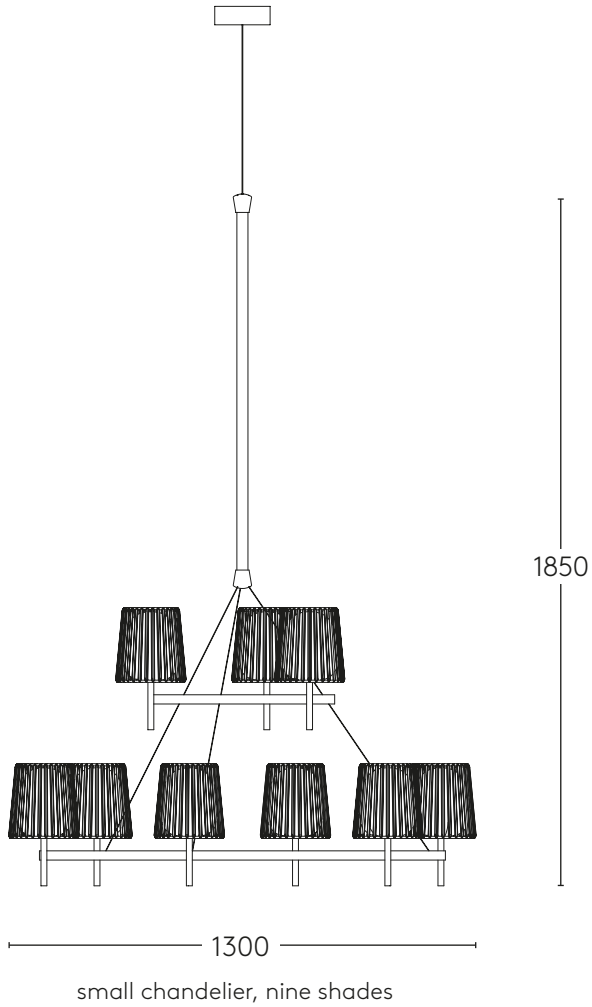

# JULIA

Circular pendants

## MATERIAL

Stainless steel  
Frosted glass

## FINISHES

polished chrome  
satin brass

bespoke finishes available on request

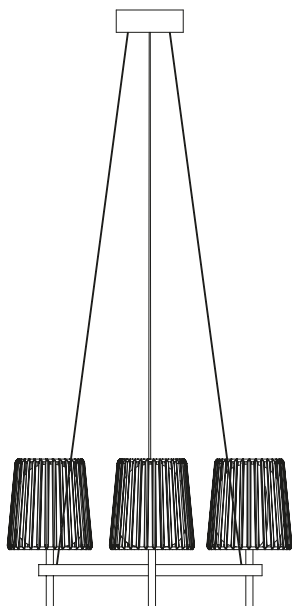

700

three shades

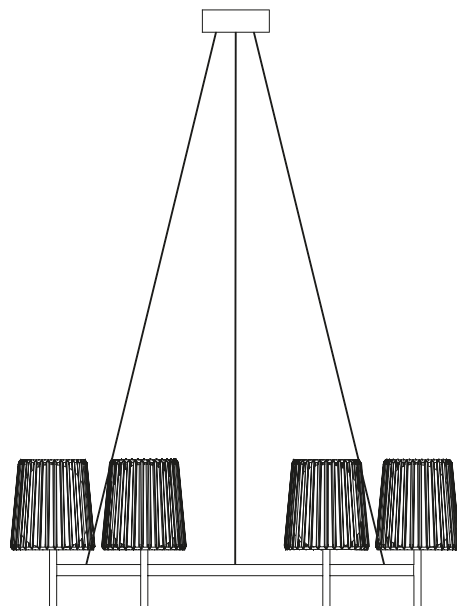

1000

six shades

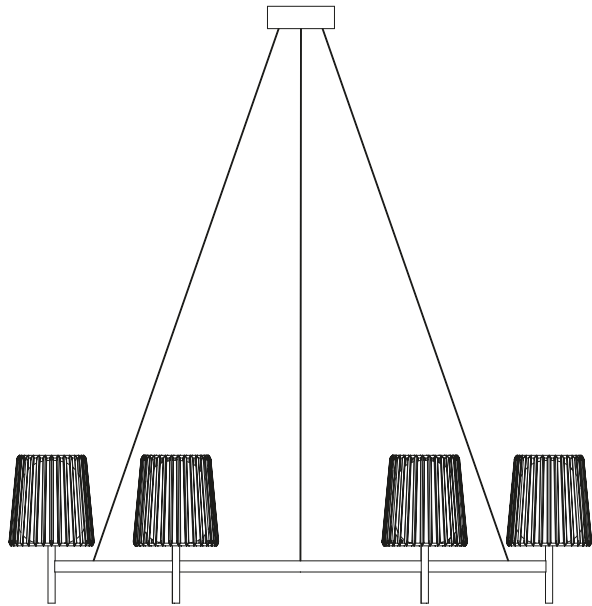

1300  
six shades

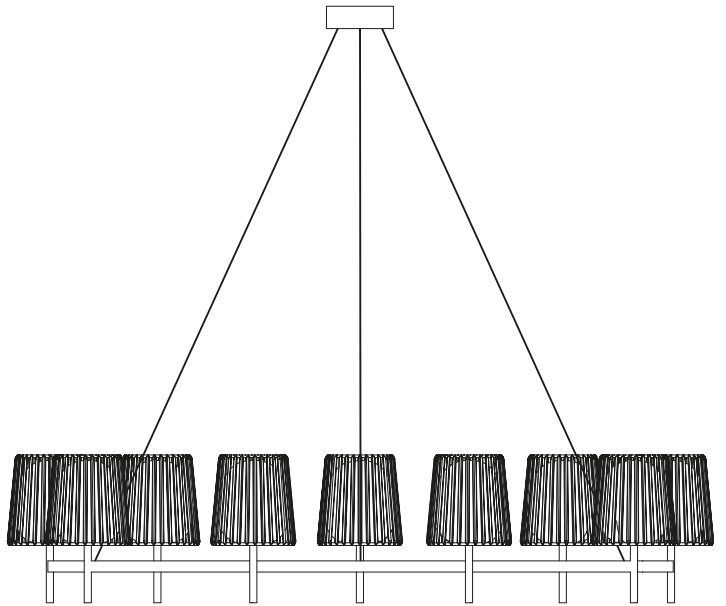

1600  
nine shades

# JULIA

Long pendants

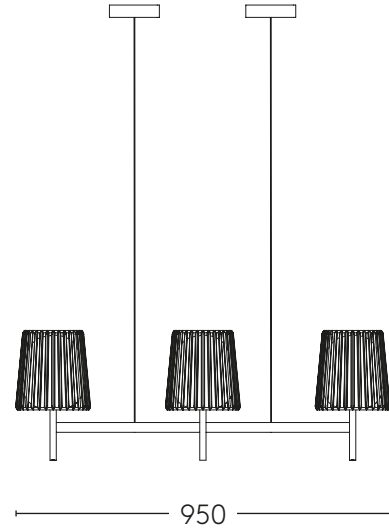

## MATERIAL

Stainless steel  
Frosted glass

## FINISHES

polished chrome  
satin brass

bespoke finishes available on request

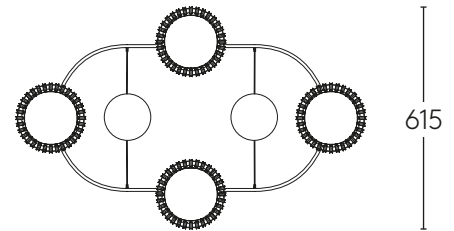

four shades



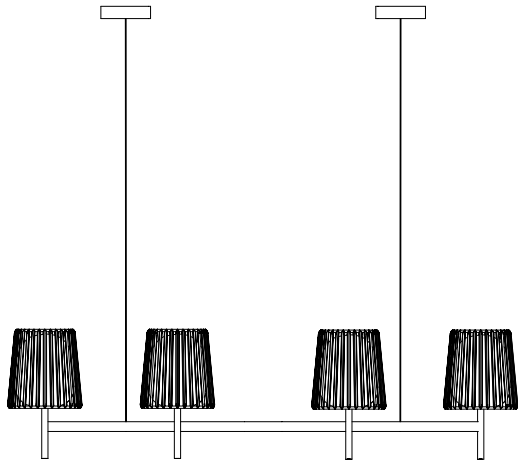

1300

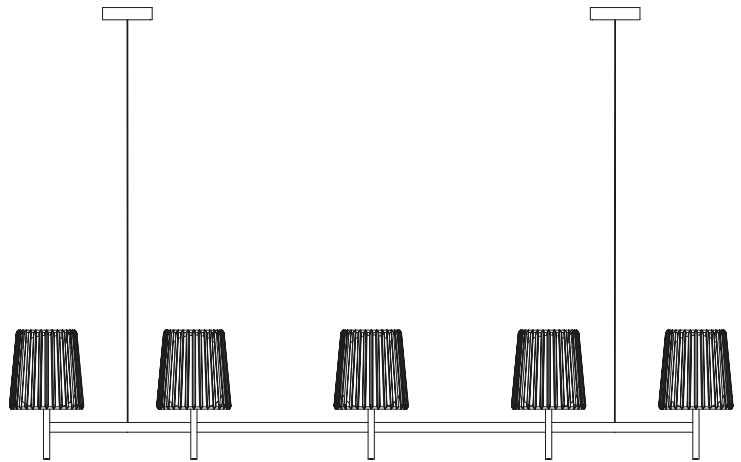

1850

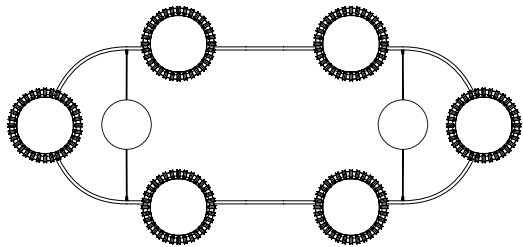

six shades

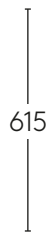

615

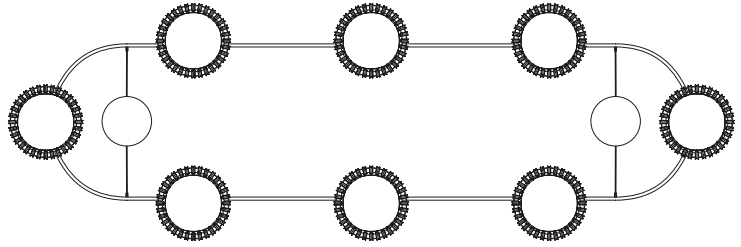

eight shades



Quasar Holland

T. +31(0)183-447887

Burgstraat 2  
4283 GG Giessen  
The Netherlands

F. +31(0)183-448337

info@quasar.nl  
www.quasar.nl